

USER MANUAL

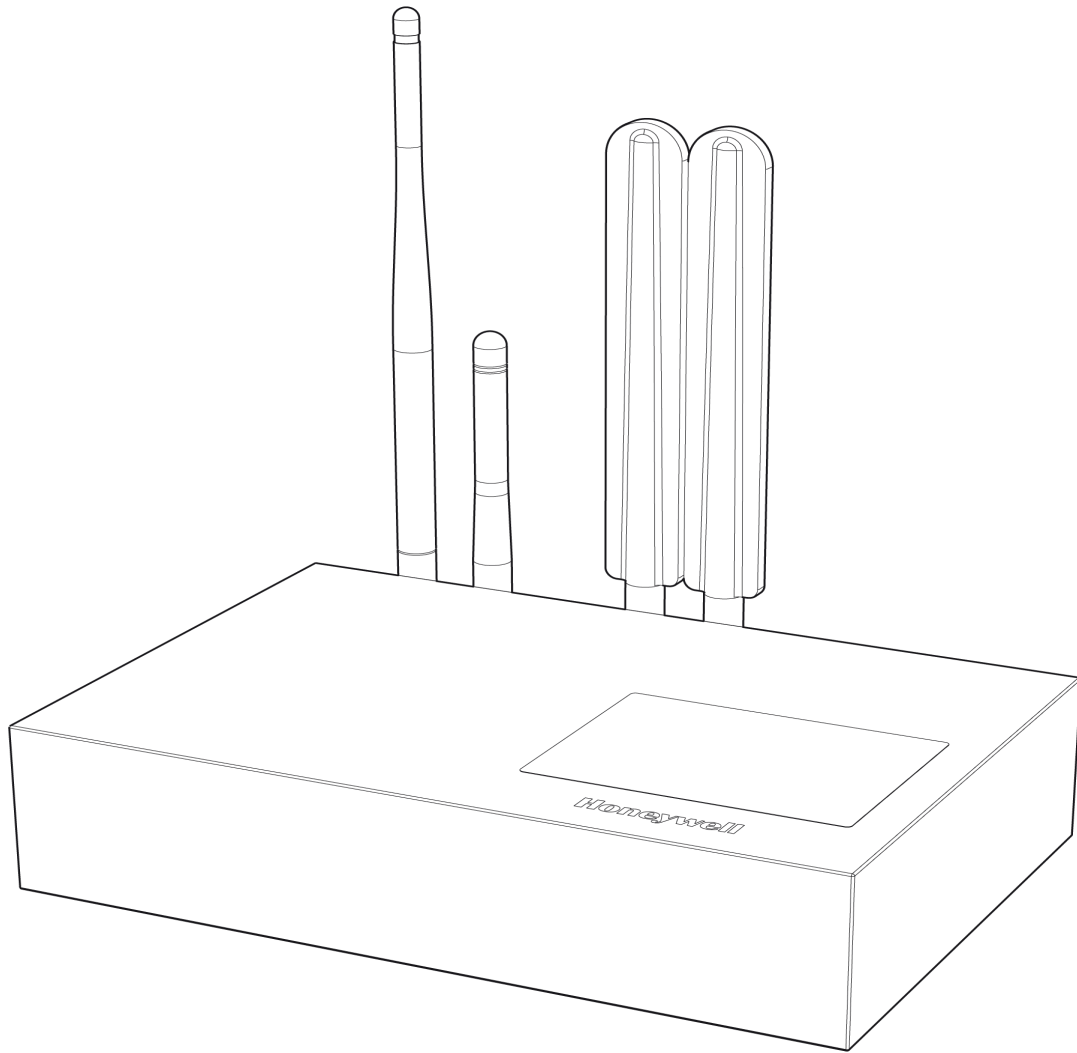

HONEYWELL CENTRAL HUB

Wireless Gas Monitor Connector

Honeywell

Table of Contents

HONEYWELL CENTRAL HUB	0
Introduction	4
About this Manual	4
Copyright Information	4
Terminology	4
Product Overview	5
Product Features	5
Specifications	6
Appearance	8
Indicator Lights	9
Installation	11
Dimensions	11
Mounting the Device	12
SIM Card and DIN Rail installation Method	13
Operation	17
Hardware Wiring	17
Software	17
Connecting a Gas Detector to Honeywell Central Hub	33
Maintenance and Precautions	35
Configuration Tool Accessories	36
Contact Us	37

1 Introduction

About this Manual

This manual describes various parameters of the gateway HCH, specific usage methods and precautions, to facilitate the operation of engineering personnel. Please read this manual carefully before use.

Copyright Information

The data and cases mentioned in this manual cannot be copied without authorization. Honeywell may revise the product during the product development process.

There are many applications for this product. Users must confirm that all operating steps and results comply with safety requirements, including laws, regulations, codes, and standards.

Terminology

LoRa: Long Range Radio is a low-power LAN wireless standard developed by Semtech. Its biggest feature is that it propagates farther than other wireless methods under the same power consumption conditions, realizing the unity of low power consumption and long distance.

LTE: Long Term Evolution is the long-term evolution of the UMTS (Universal Mobile Telecommunications System) technical standard developed by the 3GPP (The 3rd Generation Partnership Project) organization.

NFC: Near Field Communication (NFC for short) is an emerging technology. Devices using NFC technology (such as mobile phones) can exchange data when they are close to each other. It has evolved from the integration of contactless radio frequency identification (RFID) and interconnection technologies. Through the integration of inductive card readers, inductive cards, and point-to-point communication functions on a single chip, mobile terminals are used to realize mobile payment, electronic ticketing, access control, mobile identification, anti-counterfeiting, and other applications.

MQTT: a client-server-based message publishing/subscribing transport protocol, working on the TCP/IP protocol family.

2 Product Overview

Product Features

The Central Hub integrates the LoRa driver, which can collect the gas sensor data of the LoRa instrument and report it to the platform in real time through the MQTT/HTTP protocol. In addition, it also supports the transmission of data/configuration parameters through Bluetooth and gas sensor connection.

It supports three uplink connection methods, such as LTE/WiFi/WAN.

Support GPS positioning and regularly report device location information to the platform.

Support remote upgrading of device software versions through the platform.

Support storage expansion, external TF card users can save data logs, and support data log export.

Support multi-channel LoRa instrument/sensor and other equipment access

Rich uplink interface, support LTE/WAN/Wi-Fi backhaul

Multiple indicators show the working status of the equipment

TF card saves data logs, easy to maintain

Support wall-mounted, desktop, and car installation and deployment in multiple ways

Specifications

Item	Specification
Power supply	DC power supply, 12~24V/0.5A or USB Type-C input: 5V2A Note: For USB Type C input, not support the adaptors with battery fast charging protocol such as PD/QC/AFC etc.
LoRa	LoRa Private network 868/915MHz ISM band Network Capacity: <ul style="list-style-type: none"> 1 Central Hub + typical 32 devices (60s interval, 24STD+ 8RTR) Max Capacity: 64 max. (120s interval, 56STD+ 8RTR) 1 Router(RTR mode) support max 16 end devices(STD mode) Network Hops <ul style="list-style-type: none"> Max. 2 hops. (End device to Router to Central Hub.) Range/ distance <ul style="list-style-type: none"> Up to 1km (external to external antenna, line of sight.) Note: <ul style="list-style-type: none"> STD: work as a standard end device. RTR: work as a Router can bypass end device data.
Ethernet	10/100M adaptive/Central Hub setting/WAN
4G LTE	LTE FDD, CAT-4; Mini-PCIE interface; GPS (Reserved)
Wi-Fi	IEEE 802.11n, 2.4 GHz; BLE & Wi-Fi combine module.
Bluetooth	BLE 5.0 (HW reserved); BLE & Wi-Fi combine module.
Storage	Micro-SD card, 32GB memory; For local datalog
USB connector	USB Type C, backup Power input. Reserved for vehicle application by car power adaptor. See Power Supply item.
NFC reader	13.56 MHz, HW reserved.
SIM	1.8V/3.0V, plug-in card; Mini(Standard) card, 2FF. SIM card must be at least a 4GB datacard.
Key/button	Power button: On/Off; Reset buttons: Hot reset <5s; factory reset ≥5s
LED	Power/RF/LAN/Wi-Fi/LTE: Green Fault: Red
Working temperature & Humidity	-4° to 140° F (-20° to 60°C); 20%-90% RH, non-condensing

Storage temperature	-40° to 140° F (-40° to 60° C)
IP level	IP30, indoor, no hazardous area only
Size/Weight	194*131*44.5 mm/950g device, 1.7kg with package
Certification	RE-D for EU. FCC & IC for NA. Mobile Network Operator Approvals for cellular module. Safety UL/EN60950-1 for AC adaptor
Environmental	RoHS

3

Appearance

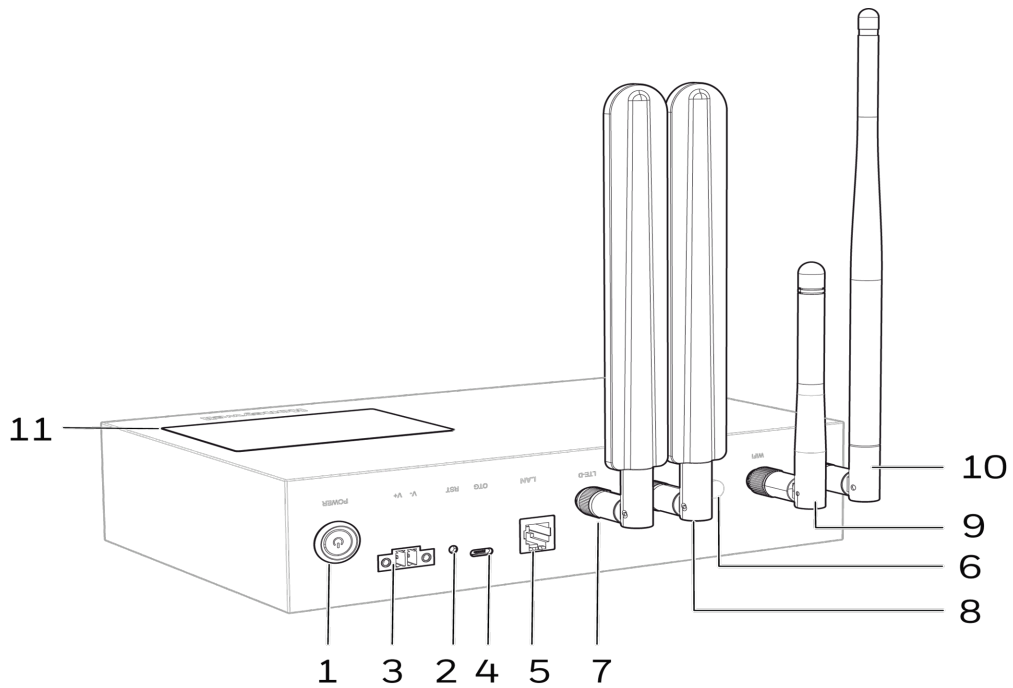

No.	Item	No.	Item
1	Power Button	7	LTE-D: 4G LTE Module Antenna Port
2	Reset Button	8	LTE-M: 4G LTE Module Antenna Port
3	Power Input Port	9	Wi-Fi Antenna Port
4	OTG-USB C	10	LoRa or Mesh Antenna Port
5	LAN Ethernet Port	11	Status Indication Lights
6	GNSS Antenna Port		

Indicator Lights

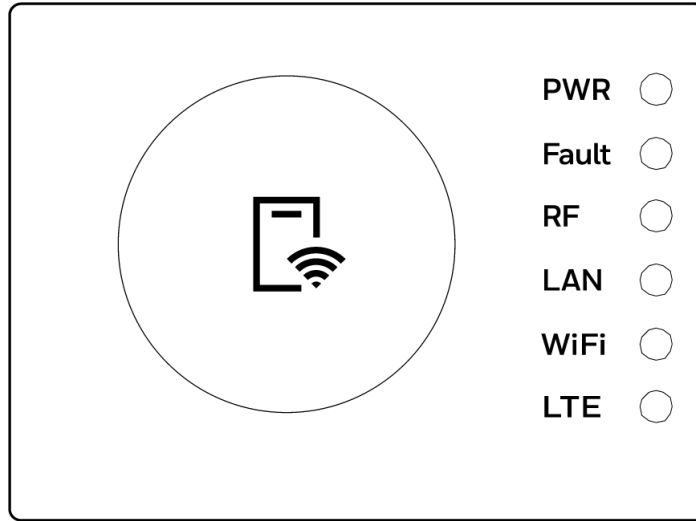

Indicator Light	Status	Meaning
PWR	Steady green	Power on the device
	Green light off	The device is not powered on
Fault	LTE uplink: The LTE light is off, and the Fault light is on	The LTE module is not recognized, the SIM card is not inserted, or the LTE network is abnormal
	Wi-Fi uplink: Wi-Fi light is off, Fault light is on	Wi-Fi Uplink Abnormal
	WAN uplink: WAN light is off, Fault light is on	WAN Uplink Abnormal
	Red light off	Equipment
RF	Steady green	The device initializes the LORA/MESH module normally
	Green light off	Device failed to initialize LORA/MESH
	Flashing green	With LORA, MESH instrument/sensor access
WAN	Green light off	The device Wi-Fi is not turned on or cannot access the AP hotspot
	Steady green	The device Wi-Fi has been connected to the AP hotspot and the communication with the internet network is normal, but it is not connected to the Honeywell Cloud platform.
	Flashing green	Device access to Honeywell Cloud platform
Wi-Fi	Green light off	The device Wi-Fi, Ethernet, or LAN is not turned on or cannot access the AP hotspot
	Steady green	The device Wi-Fi or LAN has been connected to the AP hotspot and the communication with the

		internet network is normal, but it is not connected to the Honeywell Cloud platform
	Flashing green	Device access to Honeywell Cloud platform
LTE	Green light off	The device is not connected to the LTE network
	Steady green	The device has been connected to the LTE network, but not connected to the Honeywell Cloud platform
	Flashing green	The device has been connected to the Honeywell Cloud platform
Fault RF LAN Wi-Fi LTE	5 lights all steady ON	Long push RST button ≥5s, factory reset.
	5 lights all flashing	The device software is updating.
LAN Wi-Fi LTE	3 lights all flashing 10s	When the device powers on, initialization finished, device ready for user operation.

4 Installation

Dimensions

Size: 193mm (length) * 129mm (width) * 45mm (height)

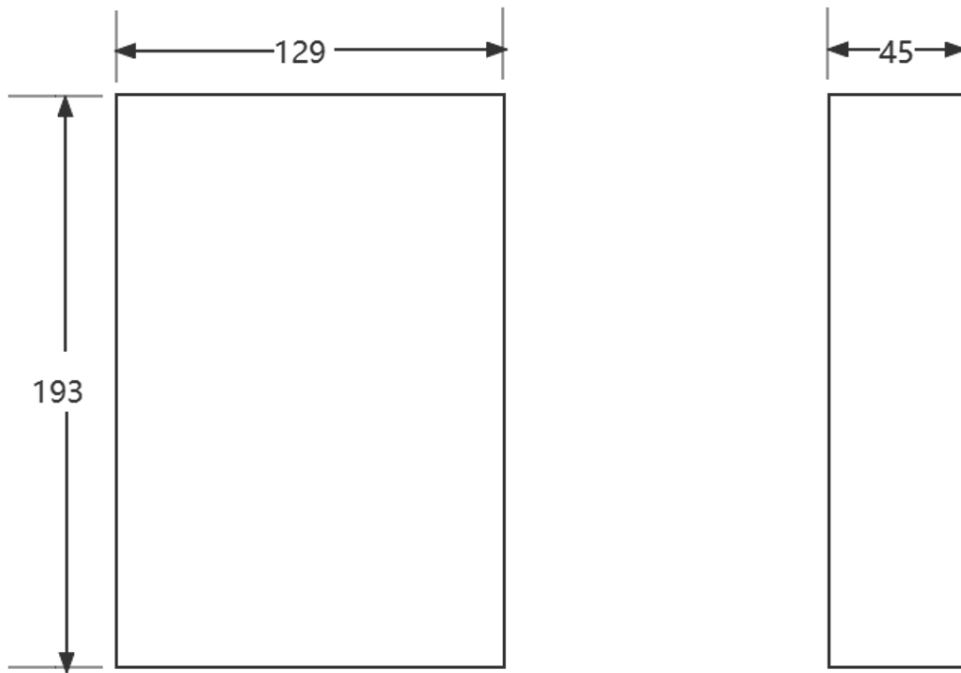

Mounting the Device

Follow the next steps to mount the device.

1. Install SIM card for LTE cellular network if required.
2. Install DIN rail if required.
3. Install the antennas:
 - There are LoRa/LTE/Wi-Fi antennas inside the box.
 - Find the LoRa antenna marked 'LORA' and connect it to the RF connector on the instrument.
 - Connect 'LTE' marked antenna to LTE-M connector and 'WIFI' marked antenna to WiFi connector.
4. Connect the power adapter to the V+/V- connector and screw tightly.

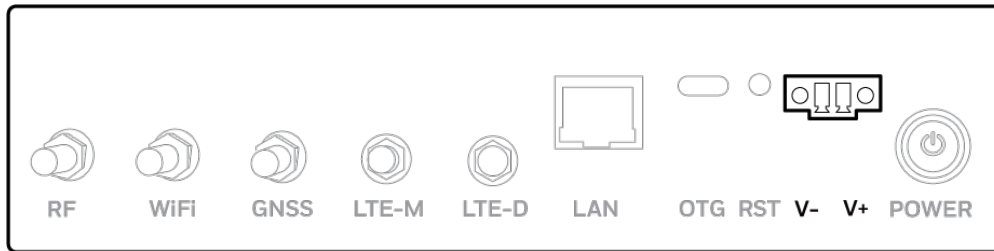

SIM Card and DIN Rail installation Method

Follow the next steps to install the device.

1. Take out the device and open the small SIM card cover on the back.

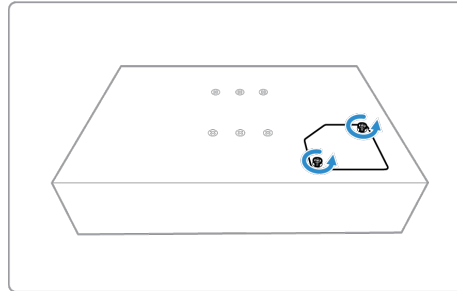

2. Open the small cover of the SIM card at the back.

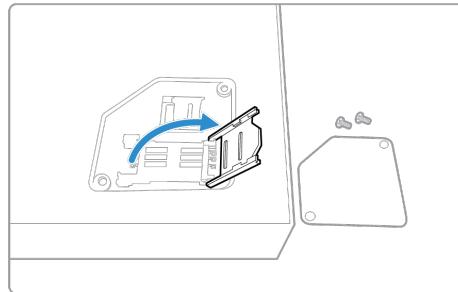

3. Look for the location of the SIM card gap and insert the SIM card. Activated Nano SIM card can be adapted to Standard size to fit into SIM card gap

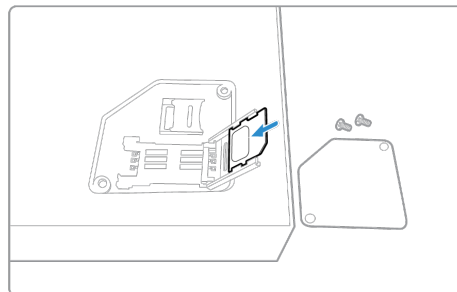

4. After loading the SIM card, push the buckle left to lock the SIM card slot tightly.

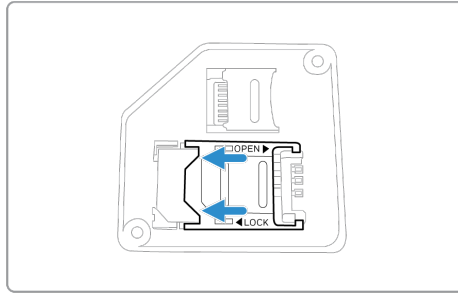

5. Put on the SIM cover and tighten the two screws (pay attention to the front and back of the cover plate)

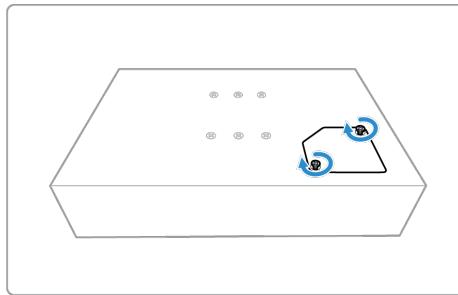

6. Remove the 6 countersunk head screws.

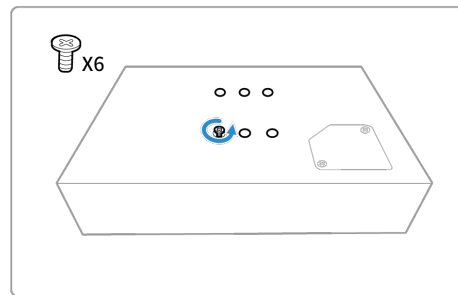

7. Replace with countersunk head screws to fix the DIN buckle. Be mindful of the direction. Do not overtighten.

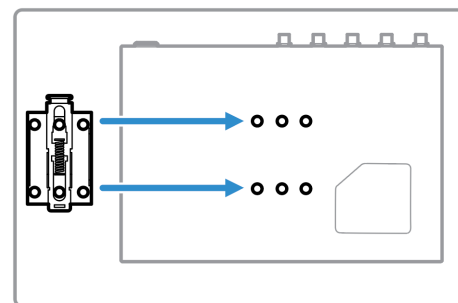

8. Hook the lower edge of the DIN rail under the buckle.

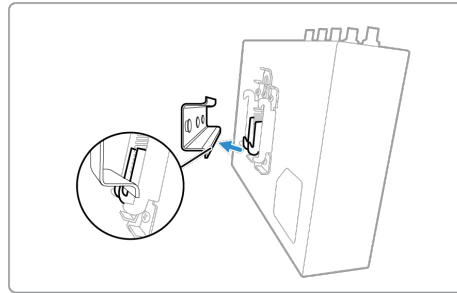

9. Pull the device up and let the hook above the buckle hook the upper edge of the DIN rail. Use a pair of slotted TS35 DIN rails (35mm high x 7.5mm deep) cut to slightly longer than the length of the assembled system, and attach to a strong wall or other rigid surface using low-profile screws.

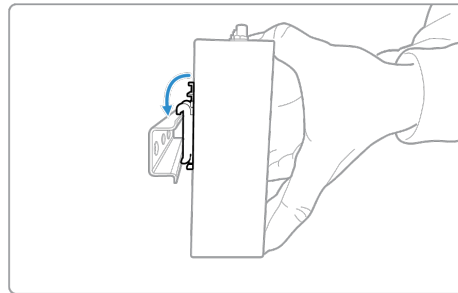

10. Install the antenna and fix it on the connector.

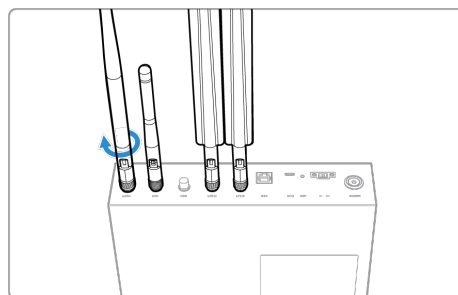

11. Install the power adapter.

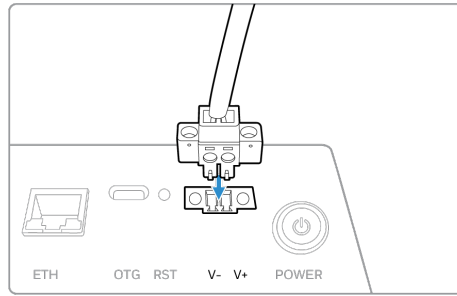

12. Lock the screws tightly to avoid loosening.

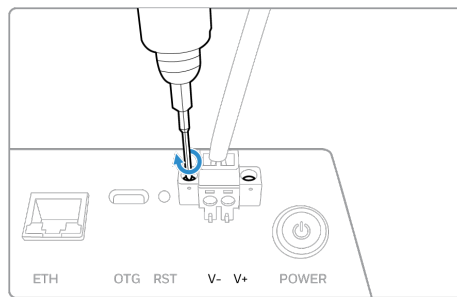

5 Operation

Hardware Wiring

The device network port is connected to the computer network port through the RJ45 network cable.

Software

Device Webpage Login

1. **Computer Configuration:** The computer's local network card automatically obtains an IP address by default, no configuration is required.

2. **Ordinary user login:**

Login URL: <https://169.254.100.1>

The default user name of ordinary users: hch300admin

Default password for ordinary users: Hon123%&

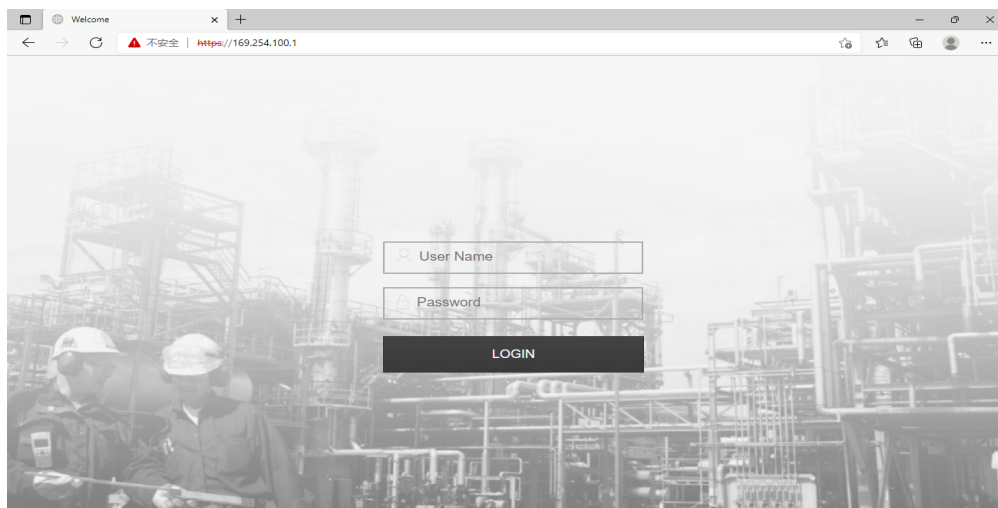

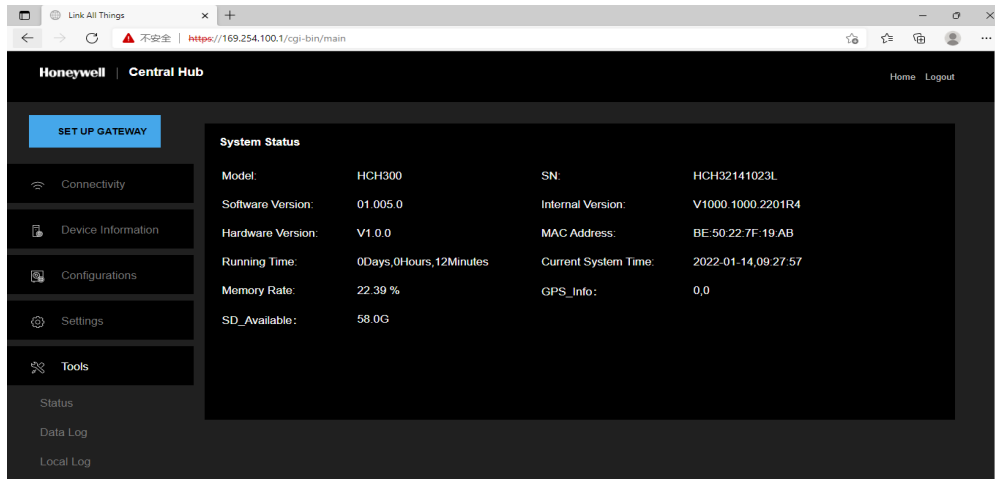

Uplink Connection Configuration

1. "LTE" uplink:

Use "LTE" uplink connection in scenarios where there is no "wired broadband" or "WiFi" wireless coverage.

Log in to the device web page, open the Network menu and click on the Uplink page; then, select the Uplink Setting as "LTE", and click the "SAVE" button to save the configuration.

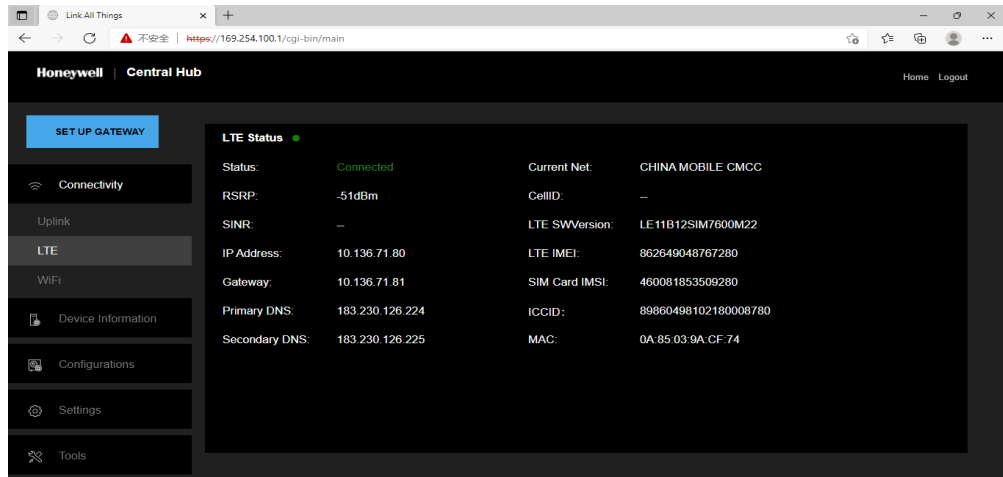

The three items for APN (Access Point Name) "APN Config", "APN User" and "APN Password" are optional. Ordinary SIM cards do not need to be configured for Internet access by default, but some IoT cards need to configure APN parameters and the user name and password for authentication. After configuration, click "SAVE" to save the configuration.

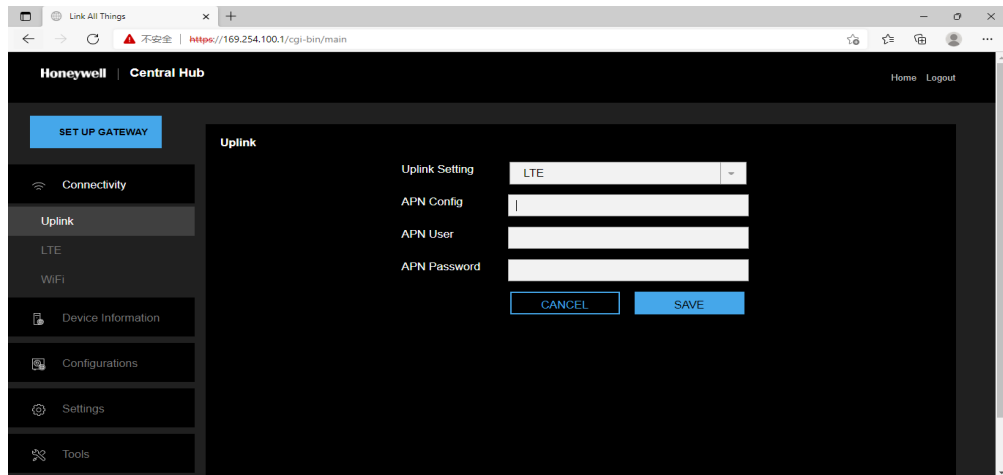

2. "WAN" Uplink:

In the scenario of providing wired network Internet access, you can select "WAN" for uplink. The WAN upstream can be configured to dynamically obtain an IP address by "DHCP" or manually configure a static IP address to access the Internet.

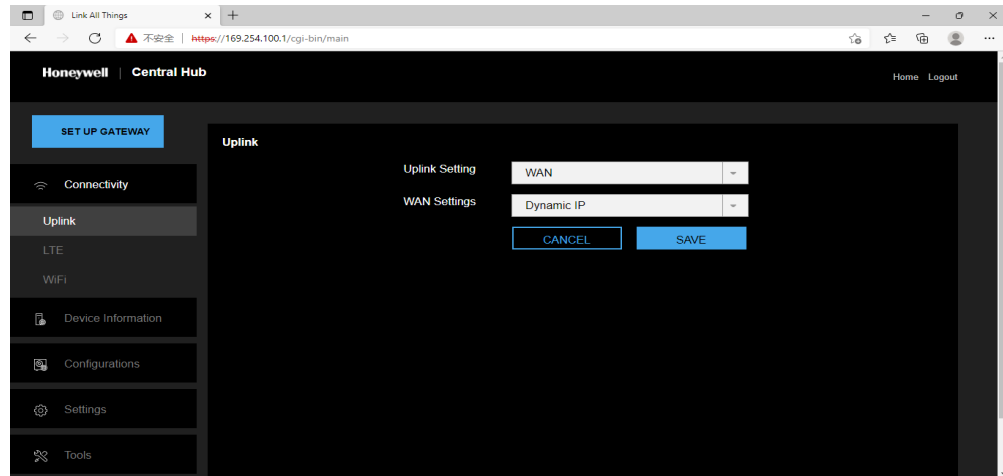

If configuring a Static IP address, please contact your IT Department for assistance.

Note: IP address shown below only as an example.

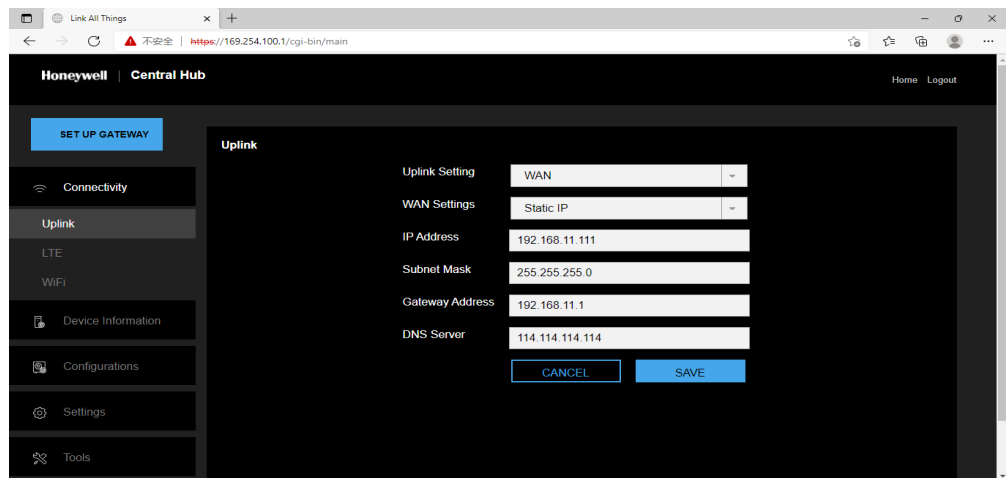

"Wi-Fi" Uplink:

In scenarios where Access Point hotspots are covered, you can use "Wi-Fi" to access the Internet. You need to fill in the "SSID name" and "Wi-Fi password" information, and then click "SAVE" to save the configuration.

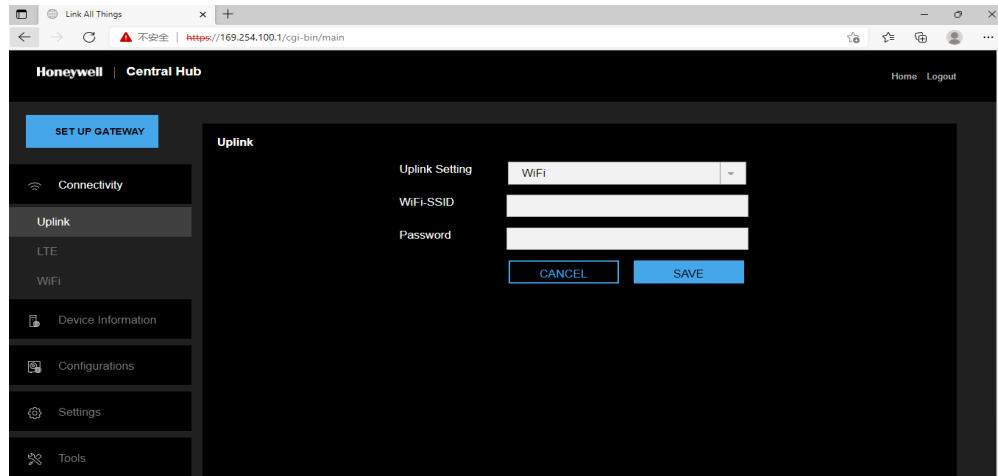

NOTE: The WiFi-SSID & Password allow to input max. 64 characters length.

Activate the Device

The SSRT Central Gateway is available for users with administrator role.

To download it follow the steps below:

1. Login with an administrator user
2. Click the Gateway option in the left navigation bar.  (If the option is not available to you, contact the administrator).
3. In the list, click the Site for which the Central Gateway will be downloaded. If there is no site, first create one with the Add option to the right.
4. In the Site screen, click the Information tab.
5. Click the Add button to the right, and select Central Hub.
6. Click Download now or Email Download Link.
7. Download activation file. Log in to the Honeywell Cloud server to download the activation file. The downloaded file is a "setup.conf" file.

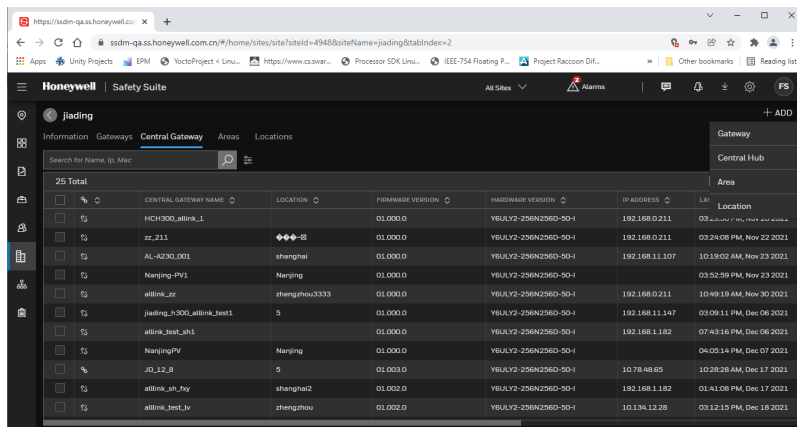
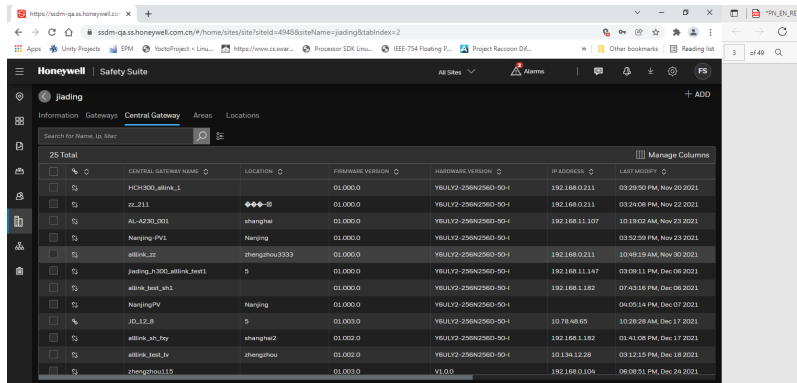

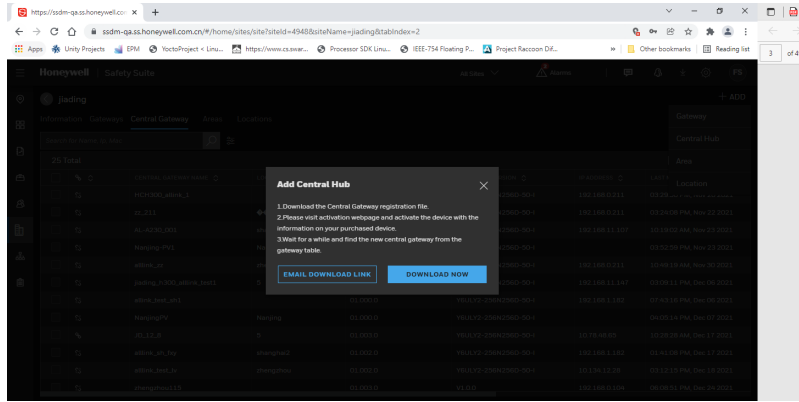

Name	Date modified	Type	Size
Today (2)			
setup.conf	1/14/2022 10:11 AM	CONF File	1 KB

8. Configure device networking. Confirm that the device is connected to the network. The device can be activated only after the device is connected to the network. See "Uplink Connection Configuration" on page 19 for more information.
9. Log into the setup gateway page to activate.
10. Set device name. Give the device a unique name and click the "Save" button to save the configuration.

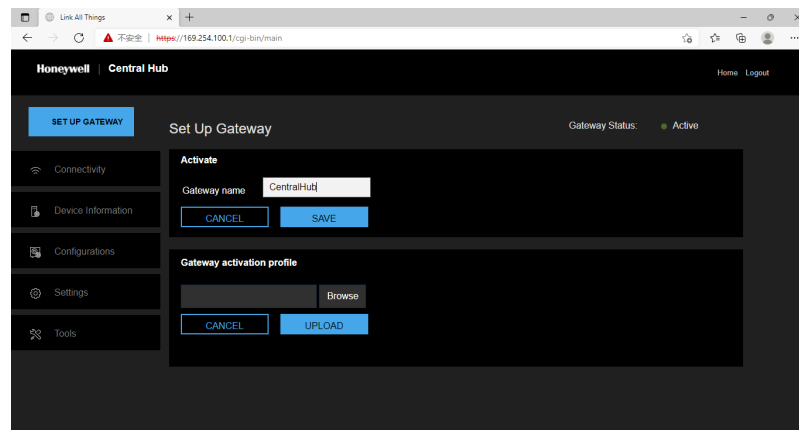

11. Activate the device. Click the "Browse" button to find the step 1) Save the local "setup.conf" path, then click "Upload", wait for about 10s, check the status and display "Activation", indicating that the device is successfully activated.

NOTE: File must be named setup.config but will upload as fakepathsetup.config

NOTE: For user who use "WAN" mode uplink HCH to Safety Suite, to activate the device follow the process below:

- Record the HCH300 device MAC address on status first page.

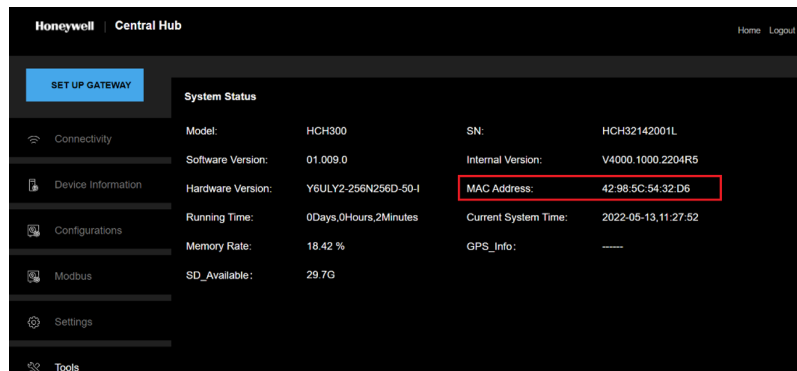

- Disconnect HCH from computer network port connection and Connect device network cable to Router LAN port. Router will assign new IP address for the HCH device.
- Visit your Router management web page and read the new IP address (ex. 192.168.8.146) by the MAC address.

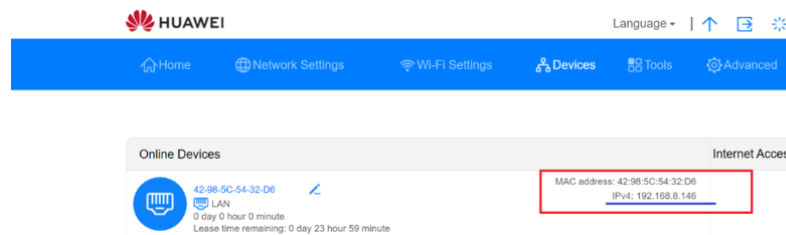

- Make sure your computer and HCH device are under the same network (ie. Start with the same first 6 digits on their IP address). Go to step 3 above and login to the device setup page on computer using the new IP address of the HCH. See below. Continue step 4 and 5 to finish activating process.

Note: IP address shown below only as an example.

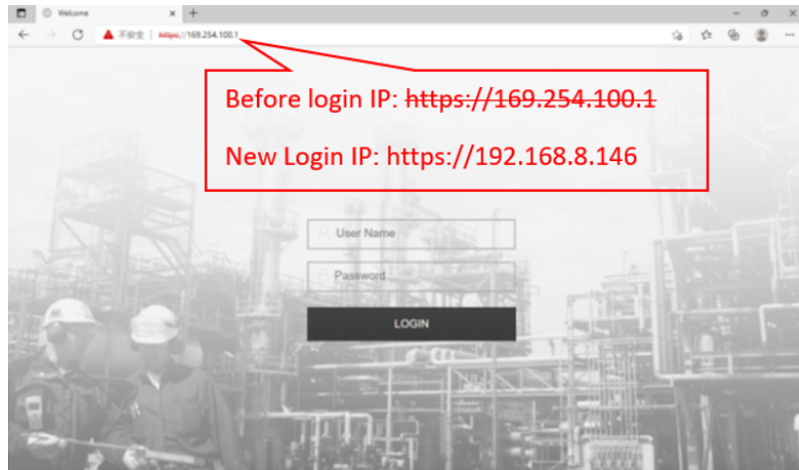

RF Parameter Configuration

1. Ordinary user login. Refer to See "Device Webpage Login" on page 17 for more information.
2. RF parameter configuration. Open the menu "Configurations" and then click on the "RF Configuration" page. Fill in the "PANID" value, select the "Channel" information, and click the "SAVE" button to save the configuration. The "RF Settings" item displays "Active" to indicate that the setting is effective.

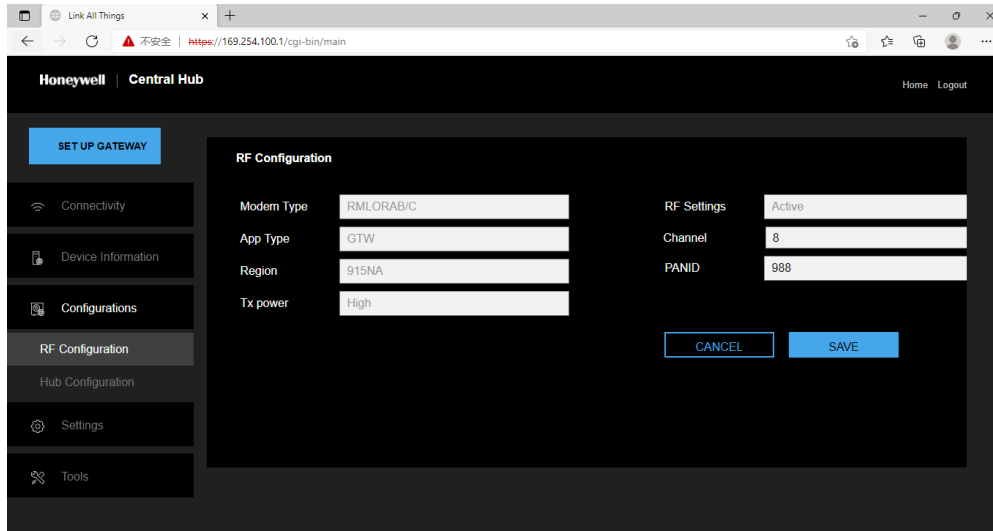

Alarm Configuration

Open the menu "Configurations" and then click on "Hub Configuration" page, there you can enable or disable the Remote Alarm and the Remote Relay, select "Enable", and then click "SAVE" to save the configuration. Location name can be set by the user to record the location name. The PreSharedSecret description is for some encryption products, like BW RigRat. You need to keep the same PreSharedSecret as the settings as in BW RigRat, if it enables this encryption.

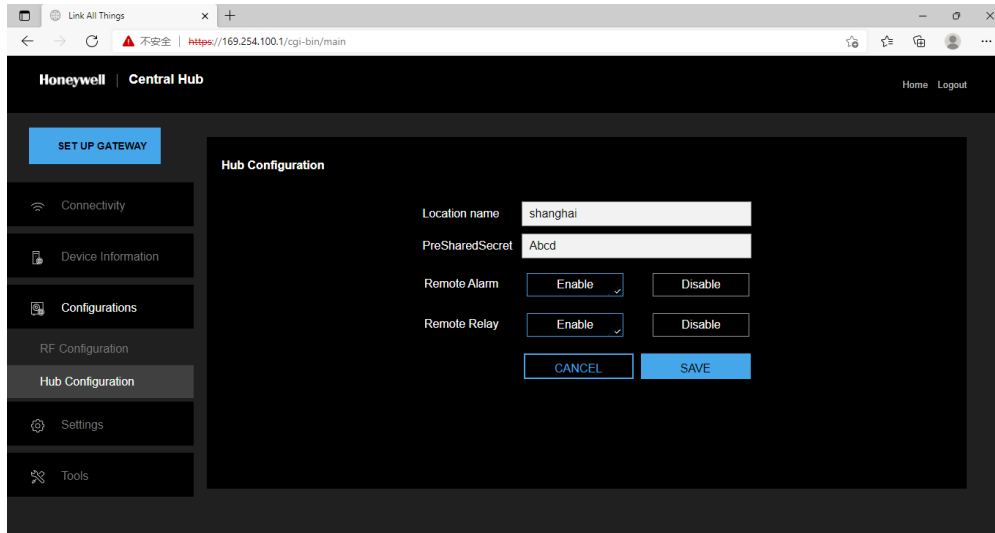

Diagnostic Information

Open the menu "Device Information" to view the related information of connected instruments and sensors.

The screenshot shows the Honeywell Central Hub web interface with the "Device Information" menu item selected. The main content area displays a table with the following data:

NO	SID	SN	DATA_PAK	DEV_INFO	SEN_FORMAT	SEN_LMT	RSSI (%)	ONLINE
1	94	1047666666	1	1	1	1	35	1
2	91	HRRD109212A7	0	1	0	0	0	0

Data Output

Open the menu "Tools" and click on the "Data Log" page. Input the date in the correct format and then click the "Export" button to export the Log data package. The data package is a .tar package, which needs to be unzipped first. The latter is a .csv file.

Note: The TF card must be inserted before the equipment is installed and used, and the data export function can be used only when the TF card is inserted in the equipment.

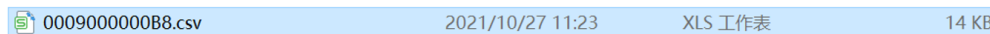
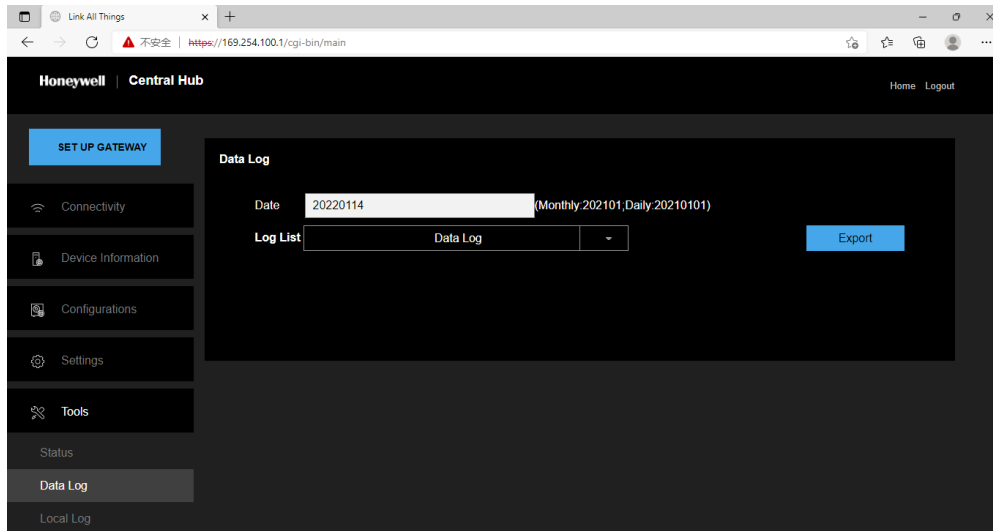

	A	B	C	D	E	F	G	H	I	J	K	L	M	N	O	P
1		instrument_name:		RigRat Pump												
2		serialNO :		0009000000B8												
3		firmware VER :		%												
4	date info	CO	H2S	SO2	NO	NO2	CL2	intrument	gps info	signal						
5	Sat Oct 21	0	0	0	0	0	0	0	unit_err	NULL	0					
6	Sat Oct 21	0	0	0	0	0	0	0	unit_err	NULL	0					
7	Sat Oct 21	0	0	0	0	0	0	0	unit_err	NULL	0					
8	Sat Oct 21	0	0	0	0	0	0	0	unit_err	NULL	0					
9	Sat Oct 21	0	0	0	0	0	0	0	unit_err	NULL	0					
10	Sat Oct 21	0	0	0	0	0	0	0	unit_err	NULL	0					
11	Sat Oct 21	0	0	0	0	0	0	0	unit_err	NULL	0					
12	Sat Oct 21	0	0	0	0	0	0	0	unit_err	NULL	0					
13	Sat Oct 21	0	0	0	0	0	0	0	unit_err	NULL	0					
14	Sat Oct 21	0	0	0	0	0	0	0	unit_err	NULL	0					
15	Sat Oct 21	0	0	0	0	0	0	0	unit_err	NULL	0					
16	Sat Oct 21	0	0	0	0	0	0	0	unit_err	NULL	0					
17	Sat Oct 21	0	0	0	0	0	0	0	unit_err	NULL	0					
18	Sat Oct 21	0	0	0	0	0	0	0	unit_err	NULL	0					
19	Sat Oct 21	0	0	0	0	0	0	0	unit_err	NULL	0					
20	Sat Oct 21	0	0	0	0	0	0	0	unit_err	NULL	0					
21	Sat Oct 21	0	0	0	0	0	0	0	unit_err	NULL	0					
22	Sat Oct 21	0	0	0	0	0	0	0	unit_err	NULL	0					
23	Sat Oct 21	0	0	0	0	0	0	0	unit_err	NULL	0					

Software Version Upgrade

1. Version upgrade. Open the "Settings" menu and click on "Software Upgrade". First click the "Browse" button to find the version path, and then click the "Upgrade Version" button to upgrade the device version. The upgrade process takes about 3 minutes.

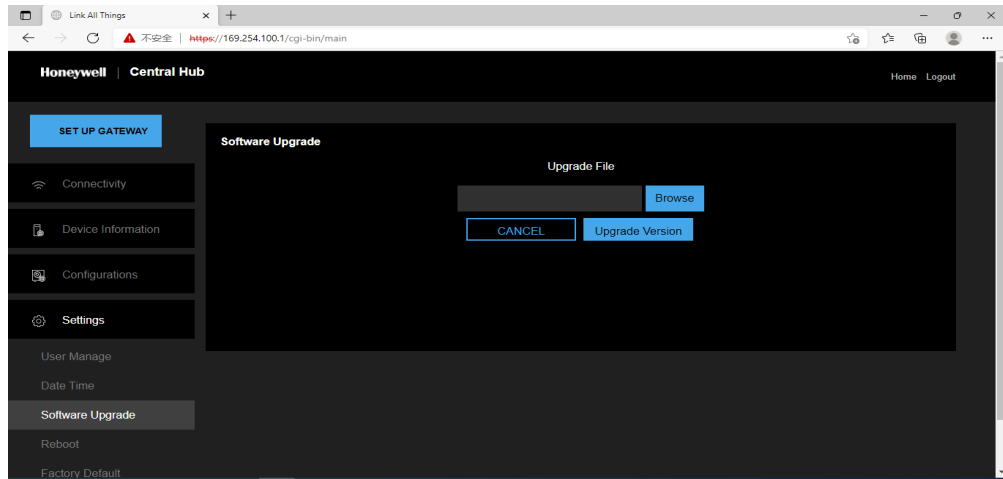

2. Version check. After the upgrade is complete, log in to the web page again and open the menu by clicking on the Honeywell name on the top left of the screen to check whether the current running version is the target version to be upgraded.

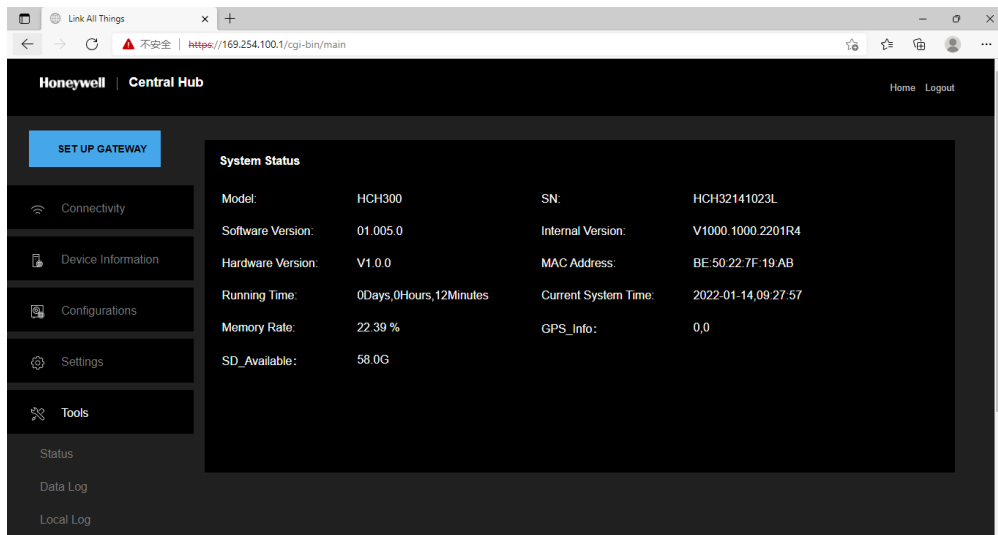

Change Username/Password

1. Ordinary user modification. Ordinary users log in to the web page and open the "Settings" menu and click on "User Manage" page to enter a new user name and password (the password must be entered twice and the password must be the same), and click "SAVE" to save the configuration.

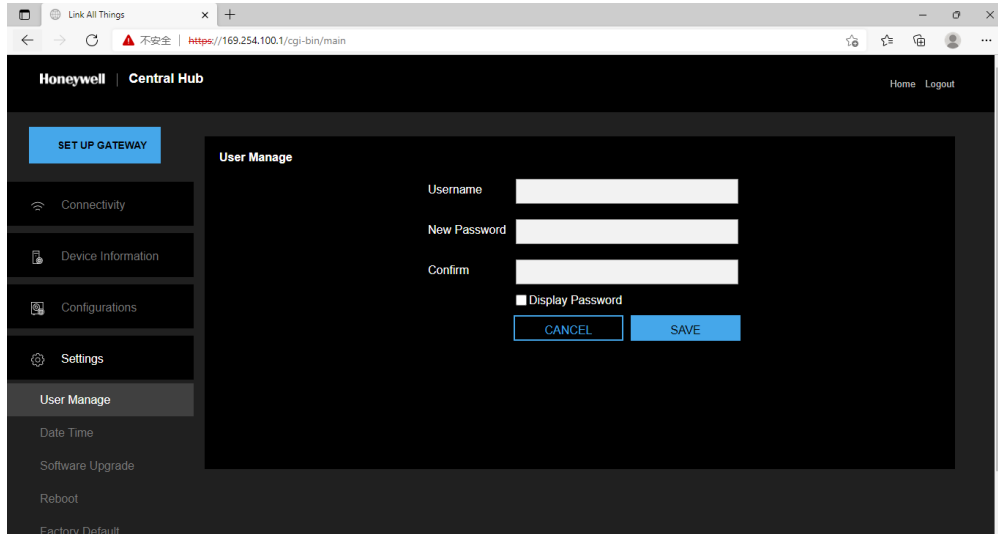

Restore Factory Configuration

Open the "Settings" menu and click on "Factory Default", then click the "Reset to factory" button to restore the device configuration to the factory configuration.

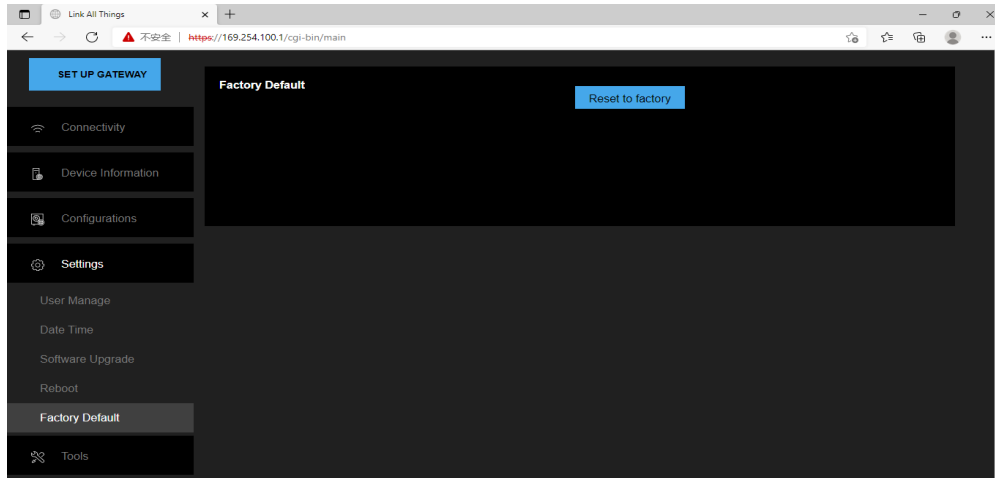

System Status View

Click on the Honeywell logo to open the "System Status" page. Here you can view the system status, such as: product model, product serial number, software version, hardware version, running time, current system running time, memory rate, GPS positioning information, TF Card information, etc.

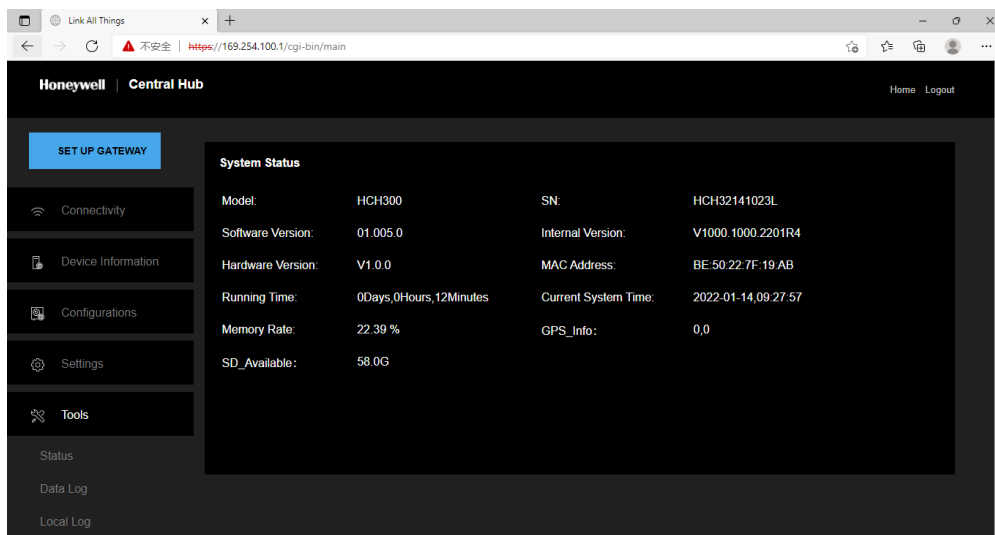

LTE Connection Status Check

Open the "Connectivity" menu and click on "LTE Status" page. You can view the LTE status, such as: network status, currently connected operator information, signal strength, LTE module IMEI number, SIM card IMSI number, obtained IP address, and Secondary DNS.

"Status" shows "Connected" and the "IP Address" item shows that the IP address has been obtained, indicating that the device is connected to the Internet.

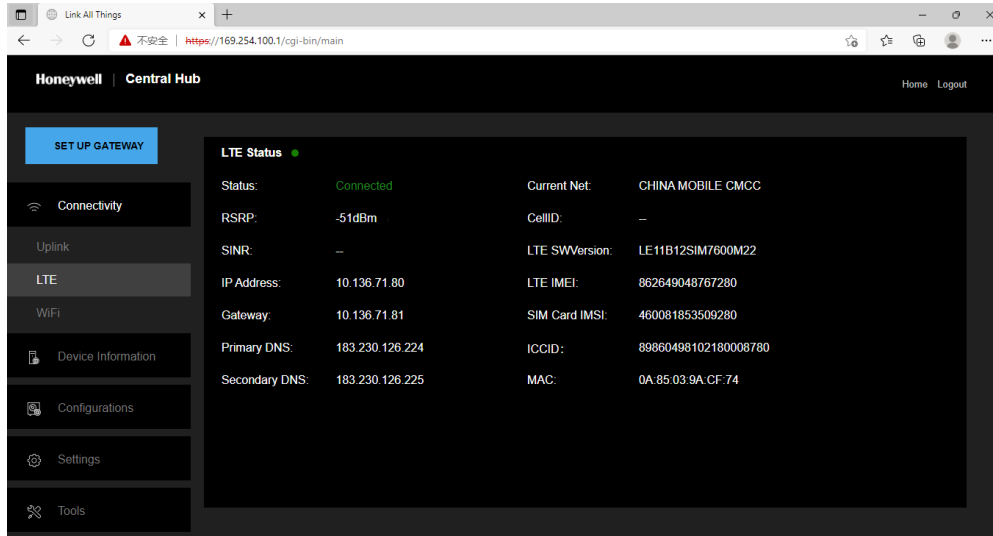

Connecting a Gas Detector to Honeywell Central Hub

To connect a Gas Detector to the Honeywell Central Hub follow the next steps:

1. Turn on the Honeywell Central Hub.
2. Connect the HCH and laptop or PC by a network cable.
3. Open Microsoft Edge browser and input the login URL, user name, and password on product label.

Login: <https://169.254.100.1>

User Name: hch300admin

Password: Hon123%&

4. Set PAN ID and Channel on HCH on the tab "RF Configuration".

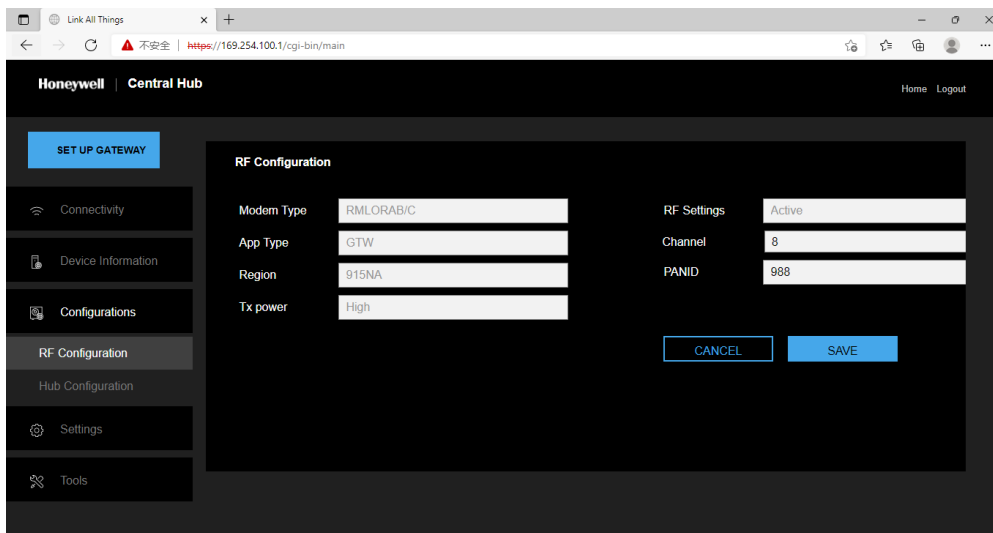

5. The Gas Detector should be set to the same PANID and channel. You can find the gas detectors on the tab “Device Information”.

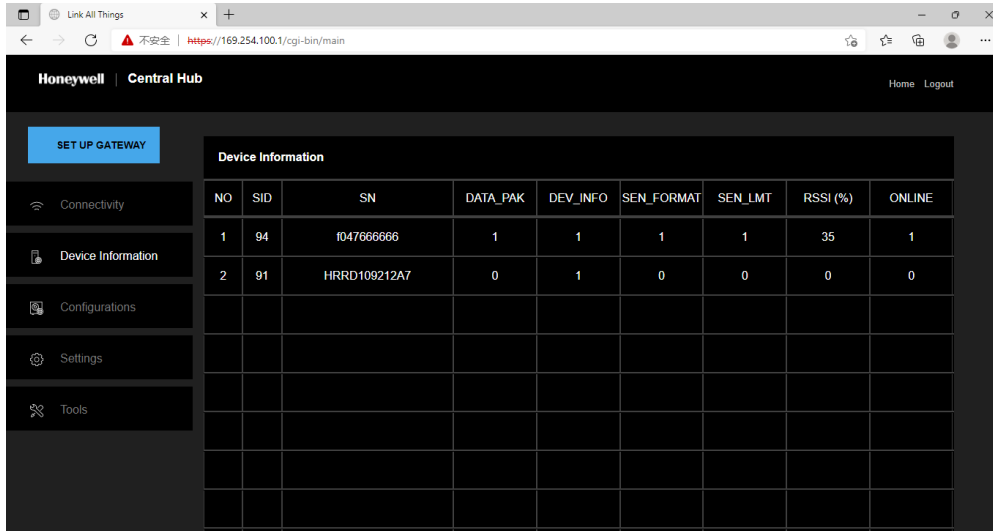

The screenshot shows the Honeywell Central Hub web interface. The browser address bar displays <https://169.254.100.1/cgi-bin/main>. The page title is "Honeywell | Central Hub" with "Home" and "Logout" links. A sidebar on the left contains navigation options: "SET UP GATEWAY", "Connectivity", "Device Information", "Configurations", "Settings", and "Tools". The main content area is titled "Device Information" and contains a table with the following data:

NO	SID	SN	DATA_PAK	DEV_INFO	SEN_FORMAT	SEN_LMT	RSSI (%)	ONLINE
1	94	1047666666	1	1	1	1	35	1
2	91	HRRD109212A7	0	1	0	0	0	0

6. Use one of the three available uplink approaches (Ethernet, Wi-Fi, or LTE) if you want to connect to Honeywell Safety Suite. See [User Manual](#) for more information.

6

Maintenance and Precautions

- The equipment should be protected from heavy pressure and damage to the front panel.
- The equipment must be protected from impact, which may damage the internal structure.
- The power supply voltage is controlled within the required range of the manual to prevent the equipment from burning out.
- The equipment needs to prevent water from entering, which will affect normal operation.
- Please check the wiring before powering on to avoid any wrong connection or short circuit.

Configuration Tool Accessories

Appearance

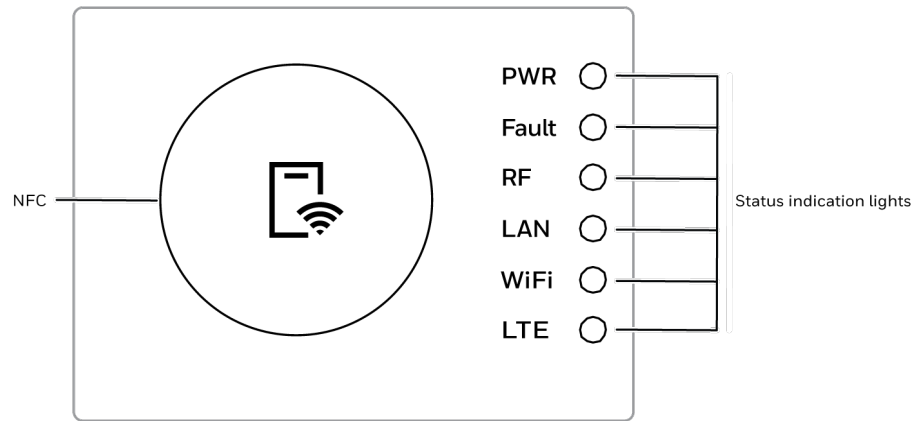

Interface

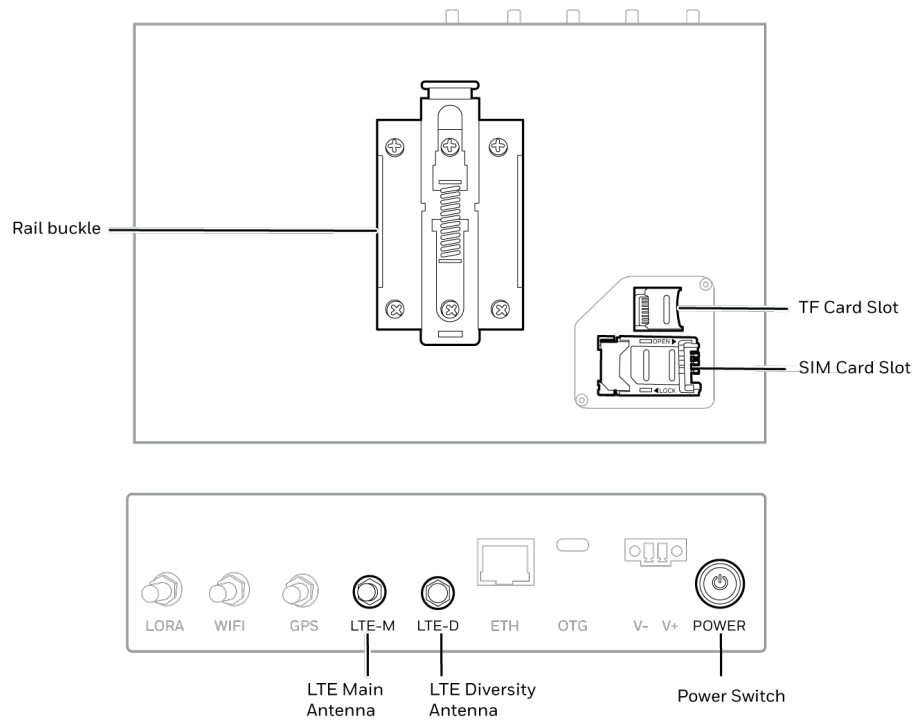

8

Contact Us

CORPORATE HEADQUARTERS

Honeywell

700 Mint St.

Charlotte, NC 28202, USA

For BW:

Toll free: +1 800 538 0363

Email: detectgas@honeywell.com

For RAE:

Toll free: +1 888 749 8878

Email: rae-callcenter@honeywell.com

RAE HEADQUARTERS

RAE Systems by Honeywell

1349 Moffett Park Drive

Sunnyvale, CA 94089 USA

Phone: 408.952.8200

RAE-tech@honeywell.com

WORLDWIDE SALES OFFICES

USA/Canada 1.877.723.2878

Europe +800.333.222.44/+41.44.943.4380

Middle East +971.4.450.5852

China +86.10.5885.8788-3000

Asia Pacific +852.2669.0828

